

A FORCE METHOD FOR ELASTIC-PLASTIC ANALYSIS OF FRAMES BY QUADRATIC OPTIMIZATION

NÉSTOR ZOUAIN PEREIRA, LAVÍNIA ALVES BORGES
and MILDRED BALLIN HECKE

Department of Mechanical Engineering, Catholic University of Rio de Janeiro, Rua Marques de São Vicente 225, Rio de Janeiro—22453, Brazil

(Received 12 December 1986; in revised form 25 May 1987)

Abstract—A numerical method for the analysis of elastoplastic planar frames is developed on the basis of a minimum principle in finite increments of stresses and plastic factors. Local elastic unloading and plastic admissibility of final stresses are considered in this theoretical formulation, avoiding additional iterative procedures. Since all possible stress distributions can be represented exactly, only an interpolation of plastic multiplier fields is required to transform the formulation in the functional space into a problem with a finite number of variables. Plastic admissibility for any section along a beam element is substituted by a finite number of constraints. The interpretation of this approximation is used to choose appropriate interpolation bases. The resulting discrete version of the principle is a quadratic optimization problem solved in this work by dualization, condensation to a problem in plastic factors only, and application of Lemke's algorithm. The advantages of the force method when compared with kinematical approaches for planar frames are discussed and demonstrated by examples.

1. INTRODUCTION

The evolution of stresses and deformations in an elastoplastic structure under a loading process can be analyzed by solving a sequence of discrete problems that are generated by means of optimization concepts[1–3], instead of the frequently used sequence of Newton iteration schemes. The loading process is divided into finite steps and statical or kinematical minimum principles are stated in terms of fields of finite increments of displacements, stresses and plastic multipliers. These formulations in finite increments are approximate because yielding followed by local elastic unloading cannot be obtained in a single load step. However, local elastic unloading starting at the beginning of the step, equilibrium and plastic admissibility of final stresses, are all taken into account by the extremum principle. Then, exact equilibrium and plastic admissibility are ensured, for piecewise linear plastic relations, without any additional iterative procedure.

In planar frames all possible stress distributions in equilibrium with a given load can be represented as a linear combination of known fields with a finite number of variable coefficients. Consequently, a statical formulation should be preferred because the exact expression of stresses can be used to discretize the problem.

The aim of this work is to show that the simplest discrete version of the statical formulation is obtained when the plastic admissibility constraint is approximated by averaging the plastic function with the same functions used as interpolation basis for plastic multipliers. The resulting numerical method does not introduce fictitious redundancy in the element, a phenomenon frequently experienced when the kinematical approach is adopted.

Some interpolation functions for plastic multipliers are chosen by considering that they should approximate the solution fields, which are non-negative everywhere, and properly average plastic functions. The effectiveness of these finite elements is demonstrated by examples.

2. KINEMATICS, EQUILIBRIUM AND CONSTITUTIVE RELATIONS

The kinematics of small deformations of a structure is described in terms of the position vector x for points of region V , and vector u identifying generalized displacements.

Displacement fields u , sufficiently regular and satisfying homogeneous constraints in a part Γ_u of the boundary Γ of V , constitute the field space U . Let q denote generalized strains in a point x defined by means of the linear deformation operator \mathcal{D}

$$q = \mathcal{D}(u). \quad (1)$$

At any stage t of the process the known loading L is specified by the body force p and the surface tractions τ , defined on the boundary Γ_τ complementary to Γ_u in Γ , so that

$$L(u) = \int_V p \cdot u \, dV + \int_{\Gamma_\tau} \tau \cdot u \, d\Gamma. \quad (2)$$

The “power” due to the load rate acting on a velocity field v is denoted by

$$\dot{L}(v) = \int_V \dot{p} \cdot v \, dV + \int_{\Gamma_\tau} \dot{\tau} \cdot v \, d\Gamma. \quad (3)$$

A distribution of generalized stresses Q equilibrates a load L if the principle of virtual work is verified

$$\int_V Q \cdot \mathcal{D}(v) \, dV = L(v) \quad \forall v \in U \quad (4)$$

and this is written $Q \in S(L)$, with $S(L)$ identifying the set of stress fields in equilibrium with a fixed load L .

The material is assumed to be linear elastic with a piecewise linear yielding limit, presenting m plastic modes, and with an associated flow rule, so that

$$\dot{Q} = D(\dot{q} - N\dot{\lambda}) \quad (5)$$

where D is the constant elasticity tensor, N is a constant matrix with each column representing a unit vector normal to the corresponding plastic mode, and $\dot{\lambda}$ the vector of m plastic multiplier rates.

The history of plastic deformation is recorded in the vector λ of accumulated plastic factors, and the yielding limit is modified according to a linear strain-hardening law. Hence the plastic function is

$$\phi = N^T Q - H\lambda - R \quad (6)$$

where superscript T denotes transpose, H is the constant hardening matrix and R is the constant vector of initial yielding limits for plastic modes[1, 2].

Vectors ϕ and $\dot{\lambda}$ verify the following complementarity relation (where inequalities hold for each vector component):

$$\phi \leq 0 \quad \dot{\lambda} \geq 0 \quad \phi \cdot \dot{\lambda} = 0. \quad (7)$$

The first inequality expresses plastic admissibility of stress and the second one imposes that plastic strain rate points outward from the elastic region. The third complementarity relation implies that no plastic strain rate is induced by a plastic mode that is inactive ($\phi_j < 0$) for the current value of Q and λ .

Whenever an active plastic mode ($\phi_j = 0$) remains active during the rate process described by $(\dot{Q}, \dot{\lambda})$ the corresponding component of the vector

$$\dot{\phi} = N^T \dot{Q} - H\dot{\lambda} \tag{8}$$

is zero, and becomes negative in the case that this plastic mode is unloaded (local elastic unloading). Then vectors $\dot{\phi}$ and $\dot{\lambda}$ satisfy the following set of conditions :

$$\begin{aligned} \text{for } \phi_j = 0: & \quad \dot{\lambda}_j \geq 0 \quad \dot{\phi}_j \leq 0 \quad \dot{\lambda}_j \dot{\phi}_j = 0 \\ \text{for } \phi_j < 0: & \quad \dot{\lambda}_j = 0. \end{aligned} \tag{9}$$

3. KINEMATICAL AND STATICAL FORMULATIONS FOR FINITE INCREMENTS

The incremental elastoplastic problem is stated at an instant t when the actual values of the fields of displacements, stresses and plastic multipliers are assumed to be known.

Besides the classical Greenberg principle there exists a kinematical rate formulation in two fields proposed by Capurso and Maier[1-3]

$$\min_{v \in U, \dot{\lambda} \in \Lambda_\phi} \pi(v, \dot{\lambda}) \tag{10}$$

where

$$\pi(v, \dot{\lambda}) = \int_V \left[\frac{1}{2} D\mathcal{D}(v) \cdot \mathcal{D}(v) - N^T D\mathcal{D}(v) \cdot \dot{\lambda} + \frac{1}{2} (H + N^T DN) \dot{\lambda} \cdot \dot{\lambda} \right] dV - \dot{L}(v)$$

and Λ_ϕ is the set of non-negative fields $\dot{\lambda}$ having value zero in any point of the structure where ϕ is strictly negative (elastic).

With the less restrictive assumption that $\dot{\lambda}$ varies in the set Λ of non-negative fields, the following rate formulation can be stated[3] :

$$\min_{v \in U, \dot{\lambda} \in \Lambda} \pi_a(v, \dot{\lambda}) \tag{11}$$

where

$$\pi_a(v, \dot{\lambda}) = \int_V \left[\frac{1}{2} D\mathcal{D}(v) \cdot \mathcal{D}(v) - N^T D\mathcal{D}(v) \cdot \dot{\lambda} + \frac{1}{2} (H + N^T DN) \dot{\lambda} \cdot \dot{\lambda} - \frac{1}{a} \phi_t \cdot \dot{\lambda} \right] dV - \dot{L}(v)$$

and ϕ_t is the known value of the plastic function at the considered stage of the process. The functional π_a depends on the fixed small positive parameter a . The solution $(v_a, \dot{\lambda}_a)$ of this optimization problem converges, for $a \rightarrow 0^+$, to the solution $(\dot{u}, \dot{\lambda})$ of the rate elastoplastic problem.

When a finite increment of load

$$\Delta L = L_{t+\Delta t} - L_t \tag{12}$$

is considered, it is convenient to use a variational formulation in terms of finite increments of field values

$$\Delta u = u_{t+\Delta t} - u_t \quad \Delta \lambda = \lambda_{t+\Delta t} - \lambda_t. \tag{13}$$

This principle should be able to produce approximations of exact increments satisfying equilibrium and plastic admissibility of stresses at the end of the load step.

A formulation that fulfils the above mentioned condition can be derived from the second rate principle (11), setting $a = \Delta t$ and substituting in π_a the Euler approximations $\dot{u} = \Delta u / \Delta t$ and $\dot{\lambda} = \Delta \lambda / \Delta t$. The resulting principle is stated below

$$\min_{\Delta u \in U, \Delta \lambda \in \Lambda} \pi_{\Delta}(\Delta u, \Delta \lambda) \quad (14)$$

where

$$\begin{aligned} \pi_{\Delta}(\Delta u, \Delta \lambda) = \int_V [\frac{1}{2} D \mathcal{D}(\Delta u) \cdot \mathcal{D}(\Delta u) - N^T D \mathcal{D}(\Delta u) \cdot \Delta \lambda \\ + \frac{1}{2} (H + N^T D N) \Delta \lambda \cdot \Delta \lambda - \phi_i \cdot \Delta \lambda] dV - \Delta L(\Delta u). \end{aligned}$$

This kinematical extremum principle gives the exact solution of the elastoplastic problem if the actual finite step process does not include at any point of the body a plastic deformation followed by local elastic unloading. However, a process presenting local elastic unloading at the beginning of the step is correctly represented in this formulation. This kind of behaviour has been identified by Maier[1] as related to a fictitious incrementally holonomic material.

The minimization of π_{Δ} furnishes an approximation $(\Delta u, \Delta \lambda)$ to the actual increments. This approximation is related to the final stress by

$$Q_{t+\Delta t} = Q_t + D(\mathcal{D}(\Delta u) - N \Delta \lambda). \quad (15)$$

The stress field above is always strictly equilibrated by the final load, and it is plastically admissible[3].

A minimum principle for finite increments of statical variables, which ensures equilibrium and plastic admissibility of final stresses, can also be derived. It gives the exact solution under the hypothesis already discussed. This principle is a dual of the kinematical one and is written as

$$\min_{\Delta Q, \Delta \lambda} \int_V (\frac{1}{2} D^{-1} \Delta Q \cdot \Delta Q + \frac{1}{2} H \Delta \lambda \cdot \Delta \lambda) dV \quad (16)$$

under the constraints

$$\Delta Q \in S(\Delta L) \quad (17)$$

$$\phi_i + N^T \Delta Q - H \Delta \lambda \leq 0 \quad \forall x \in V. \quad (18)$$

The non-negativity of $\Delta \lambda$ is not enforced as a constraint in this statical approach but it is valid for the solution as can be observed in the corresponding optimality conditions.

The above formulation is completely equivalent to the following optimization problem:

$$\min_{\Delta Q} \max_{\Delta \lambda} \int_V (\frac{1}{2} D^{-1} \Delta Q \cdot \Delta Q + N^T \Delta Q \cdot \Delta \lambda - \frac{1}{2} H \Delta \lambda \cdot \Delta \lambda + \phi_i \cdot \Delta \lambda) dV \quad (19)$$

under the constraints

$$\Delta Q \in S(\Delta L) \quad (20)$$

$$\Delta \lambda \in \Lambda. \quad (21)$$

The plastic admissibility constraint (18) is derived as a condition for the optimal solutions in this second statical problem. Notice that the positiveness of $\Delta \lambda$ must be explicitly imposed now.

Comparing these two equivalent statical formulations we note that the former one is easier to physically interpret. It consists of the minimization of an elastic energy

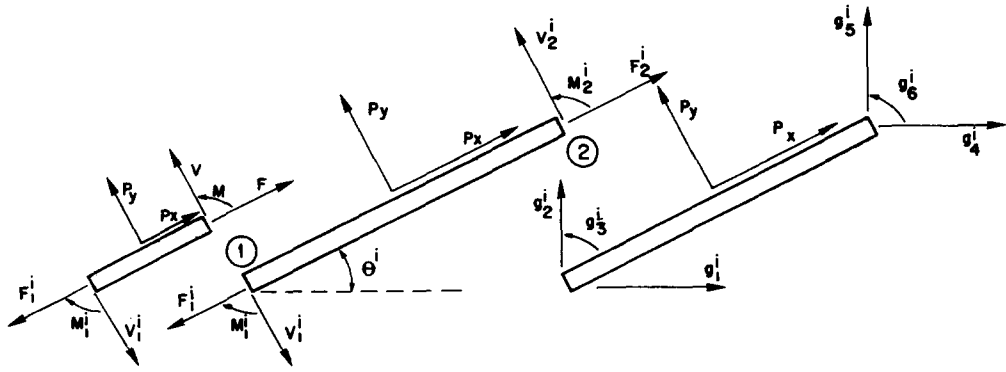

Fig. 1. Loads and generalized stresses.

corresponding to stress increments plus a dissipative term due to increments in plastic deformation, under equilibrium and plastic admissibility constraints for the state at the end of the increment. On the other hand the latter formulation seems easier to discretize because it has simpler constraints.

4. FRAME MODEL

A beam is idealized as a one-dimensional body, i.e. the coordinate \$x\$ is a scalar, and its local behaviour is described by the following generalized displacements, strains and stresses (referred to Fig. 1):

$$\hat{u} = [u_x \quad u_y]^T \tag{22}$$

$$\hat{q} = [\varepsilon \quad \kappa]^T \tag{23}$$

$$\hat{Q} = [F \quad M]^T \tag{24}$$

and the deformation operator

$$\mathcal{D} = \begin{bmatrix} \frac{d \cdot}{dx} & 0 \\ 0 & \frac{d^2 \cdot}{dx^2} \end{bmatrix} \tag{25}$$

where \$u_x\$ and \$u_y\$ are longitudinal and transversal displacements, \$\varepsilon\$ and \$\kappa\$ are longitudinal and curvature deformations of the mean line, while \$F\$ and \$M\$ are the force and moment resultants.

From now on we change the notation for the stress and plastic factor functions to \$\hat{Q}\$ and \$\hat{\lambda}\$, just to save the symbols \$Q\$ and \$\lambda\$ for the final variables, which are vectors.

The constitutive relation defined by matrices \$D\$, \$N\$, \$H\$ and \$R\$ depends on additional assumptions on the sectional behaviour. Some models for the cross-section are presented in the Appendix or found in Refs [4-7]. Matrices \$D\$, \$N\$, \$H\$ and \$R\$ are assumed to be known and related to a sectional behaviour involving \$m_s\$ plastic modes described in terms of the vectors

$$\hat{\lambda} = [\hat{\lambda}_1 \dots \hat{\lambda}_{m_s}]^T \tag{26}$$

$$\phi = [\phi_1 \dots \phi_{m_s}]^T. \tag{27}$$

The m_s plastic modes of the cross-section are usually related to the yielding of certain layers of the beam.

5. A STATICAL METHOD FOR PLANAR FRAMES

In the previous sections only the time domain has been discretized. To develop numerical methods the spatial functions must be represented or otherwise approximated, and this is usually done by means of a discretization of the structure.

The frame V is discretized in n_e beam elements V^i , of length $2l^i$, where a dimensionless variable η , varying from -1 to 1 , is defined to substitute x .

We prefer to base the development of the method on the former among the two equivalent statical principles, expressions (16) and (19), because it allows us to discuss the consequences of the approximation assumptions on the plastic admissibility constraint. The use of the latter statical formulation leads, in a simpler way, to the same quadratic program obtained in this section.

With reference to the statical formulation in finite increments given by expression (16), we consider the following sections: (i) the equilibrium constraint; (ii) the objective function; (iii) the plastic admissibility constraint; (iv) the discrete optimization problem; and (v) the selection of functions for interpolation and averaging.

5.1. Equilibrium constraint

The field \hat{Q} representing the generalized stress distribution in the frame fulfils the equilibrium condition

$$\hat{Q} \in S(L) \quad (28)$$

if along any beam element i this distribution is

$$\hat{Q} = Y(\eta)Q^i + \bar{Q}^i(\eta); \quad \eta \in [-1, 1]; \quad i = 1, \dots, n_e \quad (29)$$

where

$$Q^i = [F_1^i \quad M_1^i \quad M_2^i]^T \quad (30)$$

contains all the internal forces and moments needed to describe the generalized stress distribution along the element

$$Y(\eta) = \begin{bmatrix} 1 & 0 & 0 \\ 0 & h_1 & h_2 \end{bmatrix} \quad (31)$$

with

$$h_1(\eta) = 0.5(1 - \eta) \quad h_2(\eta) = 0.5(1 + \eta) \quad (32)$$

and

$$\bar{Q}^i(\eta) = [\bar{Q}_F^i \quad \bar{Q}_M^i]^T \quad (33)$$

with

Table 1. Equilibrium matrices B^T and \bar{g}^i

g^i	B^T			\bar{g}^i
	Q^i	F_1^i	M_1^i	M_2^i
g_1^i	$-c^i$	$s^i/2l^i$	$-s^i/2l^i$	$s^i l^i \int_{-1}^1 p_y(\eta) h_1(\eta) d\eta$
g_2^i	$-s^i$	$-c^i/2l^i$	$c^i/2l^i$	$-c^i l^i \int_{-1}^1 p_y(\eta) h_1(\eta) d\eta$
g_3^i	0	-1	0	0
g_4^i	c^i	$-s^i/2l^i$	$s^i/2l^i$	$-c^i l^i \int_{-1}^1 p_x(\eta) d\eta + s^i l^i \int_{-1}^1 p_y(\eta) h_2(\eta) d\eta$
g_5^i	s^i	$c^i/2l^i$	$-c^i/2l^i$	$-s^i l^i \int_{-1}^1 p_x(\eta) d\eta - c^i l^i \int_{-1}^1 p_y(\eta) h_2(\eta) d\eta$
g_6^i	0	0	1	0

$$c^i = \cos \theta^i, s^i = \sin \theta^i, h_1 = 0.5(1 - \eta), h_2 = 0.5(1 + \eta).$$

$$\bar{Q}_F^i(\eta) = -l^i \int_{-1}^{\eta} p_x(\eta^*) d\eta^* \tag{34}$$

$$\bar{Q}_M^i(\eta) = -2(l^i)^2 \left[h_1(\eta) \int_{-1}^{\eta} h_2(\eta^*) p_y(\eta^*) d\eta^* + h_2(\eta) \int_{\eta}^1 h_1(\eta^*) p_y(\eta^*) d\eta^* \right]. \tag{35}$$

The exact influence operator $Y(\eta)$ that gives the local stress due to Q^i , and the known stress function $\bar{Q}^i(\eta)$ due to the distributed load, imposes the correct equilibrium condition along the element, and must not be understood as an approximate interpolation function.

Let vector Q contain the components of Q^i for all elements in the frame, and the Boolean matrix L_Q^i represent the incidence relation between these vectors, then

$$Q^i = L_Q^i Q. \tag{36}$$

The stress vector for element i in the global coordinate frame

$$g^i = [g_1^i \ g_2^i \ g_3^i \ g_4^i \ g_5^i \ g_6^i]^T \tag{37}$$

defined in Fig. 1, is related to the element stress vector Q^i by the equilibrium condition

$$g^i = B^{iT} Q^i + \bar{g}^i \tag{38}$$

where the equilibrium matrix B^T and the global coordinate vector of equivalent stresses \bar{g}^i are depicted in Table 1.

The frame is subjected to distributed loads (p_x, p_y) , already considered, and concentrated loads applied at joints of beam elements. Let these nodal forces be collected in a vector P^{nod} , and the Boolean matrix L_u^i represent the incidence relation between global (displacement) degrees of freedom and element (displacement) degrees of freedom. Equilibrium for all frame joints in all unrestricted global directions reads

$$\sum_{i=1}^{n_e} L_u^{iT} g^i = P^{nod}. \tag{39}$$

Substitution of eqns (38) and (36) in the above equation leads to

$$B^T Q = P \quad (40)$$

where

$$B = \sum_{i=1}^{n_e} L_Q^{iT} B^i L_u^i \quad (41)$$

and

$$P = P^{\text{nod}} + \bar{P} \quad \bar{P} = - \sum_{i=1}^{n_e} L_u^{iT} \bar{g}^i. \quad (42)$$

To summarize the results concerning the equilibrium of the frame we note that the set $S(L)$ of the stress distribution in equilibrium with a fixed load is a linear manifold. Any stress field of this set is expressed as the sum of a linear combination of known functions, the entries of the operator Y , with the coefficients being the non-independent components of Q , and a fixed stress field, due to distributed loading and described by the function \bar{Q}^i . In fact, combining eqns (29) and (36) we get

$$\hat{Q} = Y(\eta) L_Q^i Q + \bar{Q}^i(\eta). \quad (43)$$

The vector Q is constrained to fulfil

$$B^T Q = P. \quad (44)$$

The dimension of the linear subspace that generates $S(L)$ is the number of independent components of Q , equal to $3n_e$ less the rank of matrix B (which does not contain lines corresponding to constrained degrees of freedom of the structure, assumed to be correctly supported to eliminate rigid motions).

5.2. The objective function

An appropriate approximation of the field $\hat{\lambda}$ is chosen in the form

$$\hat{\lambda} = \psi(\eta) \lambda^i \quad \eta \in [-1, 1] \quad i = 1, \dots, n_e \quad (45)$$

where $\psi(\eta)$ is the interpolation matrix and the vector λ^i contains all interpolation coefficients for element i . To simplify the selection of this interpolation it is assumed that all the components of $\hat{\lambda}$, i.e. the plastic factors of the cross-section, are approximated by different linear combinations of the same basic functions

$$f_k = f_k(\eta) \quad k = 1, \dots, n_f. \quad (46)$$

Hence

$$\psi(\eta) = [f_1 I_s | f_2 I_s | \dots | f_{n_f} I_s] \quad (47)$$

where I_s is the $(m_s \times m_s)$ identity matrix. Then, there are $n_f m_s$ components in the vector λ^i related to element i .

The components of all λ^i in the structure are collected in a single vector λ , of dimension equal to $n_e n_f m_s$. These vectors are related by the incidence Boolean matrix L_λ^i such that

$$\lambda^i = L_\lambda^i \lambda. \quad (48)$$

Substitution of eqns (43), (45) and (48) in functional (16), that can be written in the form

$$\pi = \sum_{i=1}^{n_e} \int_{V^i} (\frac{1}{2} D^{-1} \hat{Q} \cdot \hat{Q} + \frac{1}{2} H \hat{\lambda} \cdot \hat{\lambda}) dV \quad (49)$$

leads to the following expression of the objective function, when an immaterial constant is omitted :

$$\pi = \frac{1}{2} \mathbb{D}^{-1} Q \cdot Q + \bar{q} \cdot Q + \frac{1}{2} \mathbb{H} \lambda \cdot \lambda \quad (50)$$

where

$$\mathbb{D}^{-1} = \sum_{i=1}^{n_e} L_Q^T (D^i)^{-1} L_Q^i; \quad (D^i)^{-1} = \int_{V^i} Y^T D^{-1} Y dV \quad (51)$$

$$\bar{q} = \sum_{i=1}^{n_e} L_Q^T \bar{q}^i; \quad \bar{q}^i = \int_{V^i} Y^T D^{-1} \bar{Q}^i dV \quad (52)$$

$$\mathbb{H} = \sum L_\lambda^T H^i L_\lambda^i; \quad H^i = \int_{V^i} \psi^T H \psi dV. \quad (53)$$

It is important to note that the compliance matrix for the structure \mathbb{D}^{-1} is independent of the interpolation, and also that the inversion of the small size matrix of element compliance $(D^i)^{-1}$ allows the direct construction of the elastic matrix of the structure, i.e.

$$\mathbb{D} = \sum_{i=1}^{n_e} L_Q^T D^i L_Q^i; \quad D^i = \left[\int_{V^i} Y^T D^{-1} Y dV \right]^{-1}. \quad (54)$$

5.3. Plastic admissibility constraint

A stress distribution \hat{Q} is admissible, for a certain multiplier field $\hat{\lambda}$, when it is verified in any element i that

$$\phi = N^T \hat{Q} - H \hat{\lambda} - R \leq 0 \quad \forall \eta \in [-1, 1]. \quad (55)$$

This condition cannot be guaranteed in general by imposing a finite set of inequalities to constrain the coefficients collected in Q and λ .

We decide now to enforce this constraint in the average along the element, using the same set of weighting functions for any sectional plastic mode ϕ_j . We will show next that when this set of weighting functions is selected coincident with the set of shape functions f_k of the plastic factor interpolation, the simplest form of the discretized problem derived from the first statical formulation is obtained. Moreover, the resulting finite dimensional problem coincides with the one obtained by using the same interpolation for $\hat{\lambda}$ in the second statical formulation (which does not require any explicit discretization of the plastic admissibility constraint). Hence, the use of interpolation functions for transforming the plastic admissibility requirement into a finite number of constraints can be called the natural procedure for expression (16) as suggested by the penalized formulation given by expression (19).

According to the aforementioned assumptions, it is imposed in any element i that

$$\Phi_{jk}^i = \int_{V^i} f_k \phi_j dV \leq 0 \quad k = 1, \dots, n_f \quad j = 1, \dots, m_r. \quad (56)$$

Taking into account eqn (47), these constraints can be assembled in a single vector inequality for element i

$$\Phi^i = \int_{V^i} \psi^T \phi \, dV \leq 0 \quad (57)$$

where Φ^i is a vector of $n_r m_s$ components with the meaning of element plastic modes.

Vectors Φ^i are now assembled as disjoint blocks of a vector Φ for the whole structure using the same incidence matrix L_λ^i linking λ^i and λ , so that the admissibility condition becomes

$$\Phi = \sum_{i=1}^{n_r} L_\lambda^T \Phi^i \leq 0. \quad (58)$$

Substitution of eqns (57), (55), (45), (48) and (43) in the above equation results in

$$\Phi = N^T Q - H \lambda - R + \bar{\Phi} \leq 0. \quad (59)$$

Matrix H is the same matrix obtained in the computation of the objective function. This is the reason why we choose the same set of functions for interpolation and averaging purposes.

The remaining matrices in the above equation are

$$N = \sum_{i=1}^{n_r} L_Q^T N^i L_\lambda^i; \quad N^i = \int_{V^i} Y^T N \psi \, dV \quad (60)$$

$$R = \sum_{i=1}^{n_r} L_\lambda^T R^i; \quad R^i = \int_{V^i} \psi^T R \, dV \quad (61)$$

$$\bar{\Phi} = \sum_{i=1}^{n_r} L_\lambda^T \bar{\Phi}^i; \quad \bar{\Phi}^i = \int_{V^i} \psi^T N^T \bar{Q}^i \, dV. \quad (62)$$

5.4. The discrete optimization problem

According to the assumptions in Sections 5.2 and 5.3 the approximate discrete version of the statical formulation is the following quadratic programming problem :

$$\min_{\Delta Q, \Delta \lambda} \left(\frac{1}{2} \mathbb{D}^{-1} \Delta Q \cdot \Delta Q + \Delta \bar{q} \cdot \Delta Q + \frac{1}{2} H \Delta \lambda \cdot \Delta \lambda \right) \quad (63)$$

under the constraints

$$B^T \Delta Q = \Delta P \quad (64)$$

$$\Phi_r + \Delta \bar{\Phi} + N^T \Delta Q - H \Delta \lambda \leq 0 \quad (65)$$

where

$$\Phi_r = N^T Q_r - H \lambda_r - R + \bar{\Phi}_r. \quad (66)$$

This problem is formally dualized and dual variables are interpreted as discrete approximations of kinematical fields. We state in this way

$$\min_{\Delta u, \Delta \lambda} \left[\frac{1}{2} \mathbb{D} (B \Delta u - N \Delta \lambda) \cdot (B \Delta u - N \Delta \lambda) - \mathbb{D} \Delta \bar{q} \cdot (B \Delta u - N \Delta \lambda) + \frac{1}{2} H \Delta \lambda \cdot \Delta \lambda - (\Phi_r + \Delta \bar{\Phi}) \cdot \Delta \lambda - \Delta P \cdot \Delta u \right] \quad (67)$$

under the constraint

$$\Delta\lambda \geq 0. \quad (68)$$

This problem can be cast in the form

$$\min_{\Delta u, \Delta\lambda} \left[\frac{1}{2} K \Delta u \cdot \Delta u - K_{u\lambda} \Delta\lambda \cdot \Delta u + \frac{1}{2} K_{\lambda\lambda} \Delta\lambda \cdot \Delta\lambda - (\Phi_t + \Delta\bar{\Phi} - N^T \mathbb{D} \Delta\bar{q}) \cdot \Delta\lambda - (\Delta P + B^T \mathbb{D} \Delta\bar{q}) \cdot \Delta u \right] \quad (69)$$

under the constraint

$$\Delta\lambda \geq 0 \quad (70)$$

where

$$K = B^T \mathbb{D} B \quad (71)$$

$$K_{u\lambda} = B^T \mathbb{D} N \quad (72)$$

$$K_{\lambda\lambda} = H + N^T \mathbb{D} N. \quad (73)$$

The computation of these matrices can be performed at the element level because the following relations hold ($L_Q^T L_Q^i$ is an identity if $i = j$ and zero otherwise):

$$K = \sum_{i=1}^{n_e} L_u^T K^i L_u^i; \quad K^i = B^{iT} D^i B^i \quad (74)$$

$$K_{u\lambda} = \sum_{i=1}^{n_e} L_u^T K_{u\lambda}^i L_\lambda^i; \quad K_{u\lambda}^i = B^{iT} D^i N^i \quad (75)$$

$$K_{\lambda\lambda} = \sum_{i=1}^{n_e} L_\lambda^T K_{\lambda\lambda}^i L_\lambda^i; \quad K_{\lambda\lambda}^i = H^i + N^{iT} D^i N^i \quad (76)$$

$$N^T \mathbb{D} \Delta\bar{q} = \sum_{i=1}^{n_e} L_\lambda^T N^{iT} D^i \Delta\bar{q}^i \quad (77)$$

$$B^T \mathbb{D} \Delta\bar{q} = \sum_{i=1}^{n_e} L_u^T B^{iT} D^i \Delta\bar{q}^i. \quad (78)$$

Finally, elimination of Δu in the Kuhn-Tucker conditions of the latter formulation (expression (69)) leads to a linear complementarity problem for $\Delta\lambda$ and Φ

$$\Phi = a - A \Delta\lambda \quad (79)$$

$$\Phi \leq 0 \quad \Delta\lambda \geq 0 \quad \Phi \cdot \Delta\lambda = 0 \quad (80)$$

where

$$a = \Phi_t + \Delta\bar{\Phi} - N^T \mathbb{D} \Delta\bar{q} + K_{u\lambda}^T K^{-1} (\Delta P + B^T \mathbb{D} \Delta\bar{q}) \quad (81)$$

$$A = K_{\lambda\lambda} - K_{u\lambda}^T K^{-1} K_{u\lambda}. \quad (82)$$

This linear complementarity problem can be solved by a direct method, involving a finite number of iterations, such as Lemke's algorithm[8], or iterative methods closely related to the Gauss-Seidel algorithm.

Then, displacement increments are computed by means of

$$\Delta u = K^{-1}(\Delta P - B^T \mathbb{D} \Delta \bar{q}) + K^{-1} K_{ui} \Delta \lambda \quad (83)$$

and stresses as

$$\Delta Q = \mathbb{D}(B \Delta u - \mathbb{N} \Delta \lambda) \quad (84)$$

$$\hat{Q} = Q_i + Y(\eta) L_{\hat{Q}}^i \Delta Q + \bar{Q}(\eta). \quad (85)$$

Plastic admissibility along any element can be checked by computing

$$\Delta \hat{\lambda} = \psi(\eta) L_{\hat{\lambda}}^i \Delta \lambda \quad (86)$$

and using eqns (85) and (86) in eqn (55).

The main features of the proposed method are summarized below.

(1) The choice of the statical formulation allows us to take advantage of the knowledge of the exact representation for all possible stress distributions.

(2) The continuous formulation given by expression (19) requires only the plastic multiplier interpolation as the approximation necessary to transform the problem into a finite dimensional one. On the other hand, a method developed on the basis of a formulation having admissibility constraints (expression (16)) needs a further discretization to substitute these constraints by a finite number of inequalities.

(3) The same discrete version of the problem is obtained either by simply substituting an interpolation of λ in the second statical formulation, expression (19), or by using the same functions in the first one, expression (16), to approximate λ and also to average plastic admissibility constraints. Note that the matrices \mathbb{D} , \bar{q} , \mathbb{H} , \mathbb{N} , \mathbb{R} and Φ of eqns (51)–(53) and (60)–(62) can also be obtained introducing the assumed approximation of $\hat{\lambda}$, eqn (45), into the objective functional of the minimization problem of expression (19). This argument justifies the choice of weighted residuals associated with interpolation functions to discretize the admissibility constraint. In this context, the development of the method as performed in Sections 5.2 and 5.3 demonstrates the consequences of approximating $\hat{\lambda}$ on the implicit admissibility constraint of the statical formulation given in expression (19).

(4) Consider now the broader class of problems obtained from expression (16) when the interpolation basis for plastic factors is not necessarily coincident with the set of weighting functions used to discretize the admissibility constraint. This includes, for instance, the case when the constraint is treated by the collocation method, i.e. Dirac functions are used as weights, while bounded functions are chosen to approximate plastic factors. These quadratic programs have two different hardening matrices, one in the objective function and another one in the constraint. Therefore, these problems are more complex than the one obtained in previous sections. In this sense, the simplest discretization of the static formulation is given by the proposed method.

5.5. The selection of functions for interpolation and constraint averaging

The set of functions f_k defining the operator ψ must have two different properties. On one side these functions should be suitable to represent plastic factor fields expected to occur in a beam, and on the other side they must be able to detect positive values of the plastic mode ϕ_j along the beam.

Fields $\hat{\lambda}$ belonging to the domain of the considered optimization problem are not necessarily non-negative functions. That is because in the statical formulation adopted the inequality $\hat{\lambda} \geq 0 \forall \eta$ is an optimality condition rather than a primal constraint. Anyway, we can work only with non-negative functions because that is the case for the exact solution. Note that, for any kind of interpolation shapes, the coefficients $\Delta \lambda$ are non-negative in the solution. In particular, if the interpolation is chosen piecewise linear with positive basic functions, as in $L2$ to $L5$ of Fig. 2, then the non-negativity of coefficients implies the same

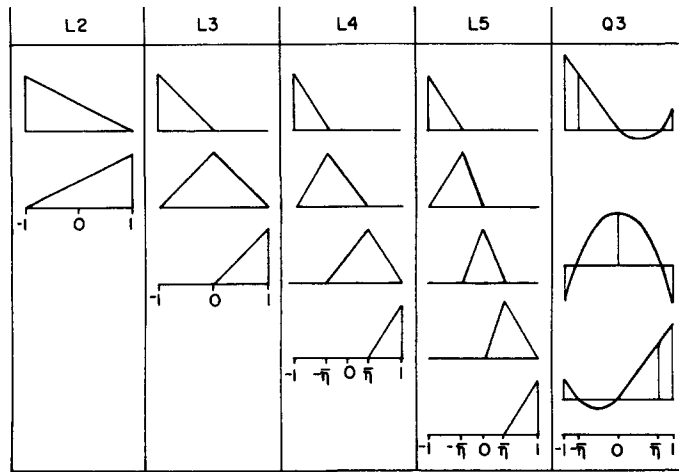

Fig. 2. Functions f_k for interpolation of plastic factors along the beam.

condition for any value of the function $\hat{\lambda}$. This situation is not reached if polynomials of degree greater than one are used.

For the purpose of weighting the yielding functions it may be convenient to use Dirac functions δ_k in points η_k ($k = 1, \dots, \eta_f$). Thus, the plastic admissibility condition is strictly enforced in the set of η_f selected points η_k . As interpolation bases, these functions produce a model for the beam made of rigid bars and plastic hinges.

When positive functions having one main peak value (resembling Delta functions) are used for averaging plastic modes, the plastic admissibility condition is approximately enforced in the vicinity of the coordinates of these peaks.

If a beam element has no distributed load, and f_k are selected as the positive basic functions of piecewise linear interpolation, then ϕ_j is also piecewise linear with coincident peaks. In this case it is sufficient to control ϕ_j at these singular points to enforce admissibility.

According to the previous discussion some appropriate finite elements, called *L2*, *L3*, *L4* and *L5*, are defined in Fig. 2. The interpolation *Q3* is included for comparison with the results in Refs [4, 7].

6. KINEMATICAL APPROACHES FOR PLANE FRAMES

Spatial discretizations of the kinematical formulation are briefly presented in what follows in order to compare them with the proposed statical method.

By means of a finite element discretization of the frame the kinematical fields are approximated in each element i as

$$\hat{u} = \psi_u(\eta)u^i \quad u^i = L_u^i u \tag{87}$$

$$\hat{\lambda} = \psi_\lambda(\eta)\lambda^i \quad \lambda^i = L_\lambda^i \lambda \tag{88}$$

where u^i and u are element and global vectors of displacement interpolation parameters, respectively.

Substitution of these approximations in the kinematical formulation for finite increments (expression (14)), leads to the following optimization problem for discrete variables Δu and $\Delta \lambda$:

$$\min_{\Delta u, \Delta \lambda} [\frac{1}{2}K\Delta u \cdot \Delta u - K_{u\lambda}\Delta \lambda \cdot \Delta u + \frac{1}{2}K_{\lambda\lambda}\Delta \lambda \cdot \Delta \lambda - \Phi_i \cdot \Delta \lambda - \Delta P \cdot \Delta u] \tag{89}$$

under the constraint (which substitutes $\Delta \hat{\lambda} \geq 0 \forall x \in V$)

$$\Delta\lambda \geq 0 \quad (90)$$

where

$$K = \sum_{i=1}^{n_r} L_u^T K^i L_u^i \quad K^i = \int_{V^i} \mathcal{B}^T D \mathcal{B}^i dV \quad (91)$$

$$K_{u\lambda} = \sum_{i=1}^{n_r} L_u^T K_{u\lambda}^i L_\lambda^i \quad K_u^i = \int_{V^i} \mathcal{B}^T D N \psi_\lambda dV \quad (92)$$

with

$$\mathcal{B}^i(\eta) = \mathcal{D}(\psi_u(\eta)) \quad (93)$$

and

$$K_{\lambda\lambda} = \sum_{i=1}^{n_r} L_\lambda^T K_{\lambda\lambda}^i L_\lambda^i \quad K_{\lambda\lambda}^i = \int_{V^i} \psi_\lambda^T (H + N^T D N) \psi_\lambda dV \quad (94)$$

$$\Phi_t = K_{u\lambda}^T u_t - K_{\lambda\lambda} \lambda_t - \mathbb{R} \quad (95)$$

$$\mathbb{R} = \sum_{i=1}^{n_r} L_\lambda^T R^i \quad R^i = \int_{V^i} \psi_\lambda^T R dV. \quad (96)$$

The equivalent load vector P has the same definition as in eqns (42) of the previous section.

To summarize the kinematical discrete formulations we note that these methods are characterized by a particular (FEM) interpolation of displacements and plastic factors, and they involve the solution of a quadratic problem similar to that appearing in the proposed static method.

In contrast to the statical method where stresses are exactly represented, the kinematical approach requires not only the approximation of plastic multipliers but the interpolation of displacements as well. This advantage of the force method is a consequence of the fact that beam elements are statically determinate, i.e. internal forces are uniquely obtained from equilibrium. This statical determination also implies that any arbitrary plastic strain distribution is kinematically admissible, i.e. for any $\hat{\lambda}$ there is a \hat{u} such that

$$\mathcal{D}(\hat{u}) = N \hat{\lambda} \quad \forall x \in V^i. \quad (97)$$

When interpolations of \hat{u} and $\hat{\lambda}$ are independently chosen, fictitious redundancies are sometimes introduced in the finite element behaviour. Independent interpolations for \hat{u} and $\hat{\lambda}$ are in accordance with the kinematical principle but fictitious redundancy is commonly associated with poor efficiency of the finite element.

The possibility of constructing ‘‘compatible finite elements’’, i.e. a pair of interpolation operators (ψ_u, ψ_λ) such that for any λ^i there is a u^i that holds eqn (97), is investigated by Corradi and Maier[4–7].

7. EXAMPLES

Several combinations of longitudinal approximations, shown in Fig. 2, with cross-sectional models are tested in simple examples in order to demonstrate the behaviour of the different finite elements defined in this way. Although we have presented the general method for frames under combined bending moment and axial force, the examples treated

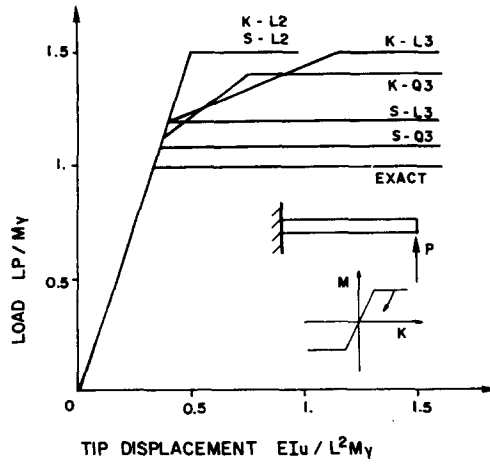

Fig. 3. Load-displacement curves for the cantilever beam with the elastic-perfectly plastic relation for moment and curvature: S, statical method; K, kinematical method with cubic displacement interpolation; L2, L3, Q3, plastic factor interpolations shown in Fig. 2 ($\bar{\eta} = \sqrt{(3/5)}$ for Q3).

only involve bending, so that we shall omit matrix components corresponding to axial forces (i.e. $\hat{Q} = [M]$ and $\hat{q} = [\kappa]$).

The first case is a cantilever beam, loaded at the free end, with elastic-perfectly plastic cross-sectional behaviour in terms of the moment-curvature relation, i.e.

$$D = [EI] \quad N = [1 \quad -1] \quad R = [M_Y \quad -M_Y]^T. \tag{98}$$

The results in Fig. 3 show that the statical approach approximates better the exact curve. The fictitious redundancy only appears in the kinematical method, resulting in contained yielding before collapse.

The second example is the same cantilever beam with cross-sectional behaviour corresponding to linear kinematic hardening in terms of the moment-curvature relation, i.e.

$$H = \alpha EI \begin{bmatrix} 1 & -1 \\ -1 & 1 \end{bmatrix}. \tag{99}$$

The exact solution for the free end displacement is

$$u(L) = \frac{L^2 M_Y p}{EI} \frac{p}{3} \quad \text{for } p \leq 1 \tag{100}$$

$$u(L) = \frac{L^2 M_Y}{EI} \left[\frac{p}{3} + \frac{(p-1)^2(2p+1)}{6\alpha p^2} \right] \quad \text{for } p > 1 \tag{101}$$

where p is the dimensionless load LP/M_Y .

The results in Fig. 4 (for $\alpha = 1/3$) demonstrate the convergence of the approximation when the number of interpolation parameters increases.

In the following two examples the beam has rectangular cross-section and it is made of elastic-plastic homogeneous material. Several approximations of the sectional behaviour are derived from the interpolation functions in Fig. 5 by using some equations derived in the Appendix. These functions are the positive piecewise linear bases (i.e. same as in Fig. 2) written in terms of bending plastic modes.

The third example is the cantilever beam with homogeneous rectangular cross-section. The exact tip displacement is

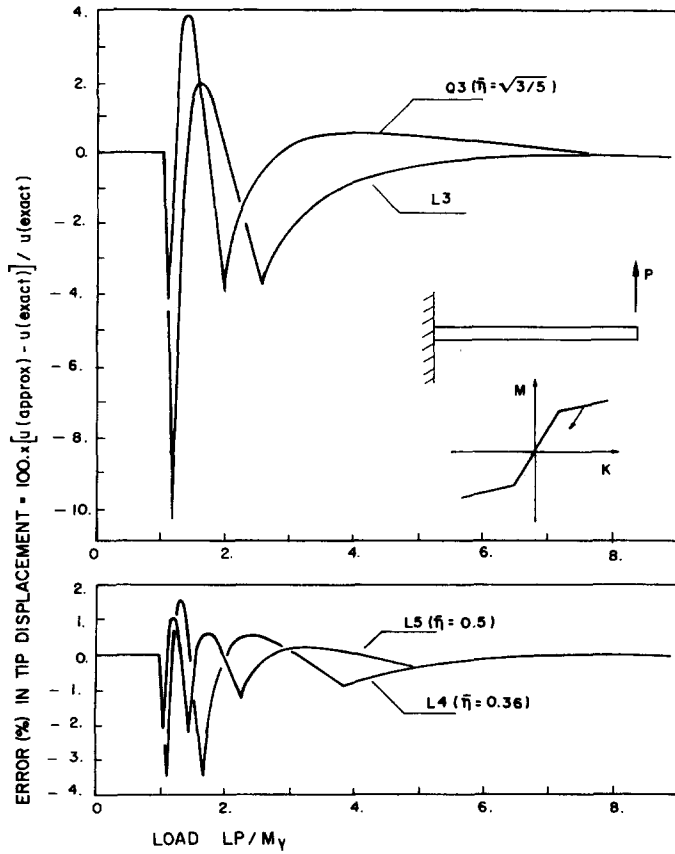

Fig. 4. Load-displacement curves for the statical method applied to a beam with linear hardening in terms of the moment-curvature relation ($\alpha = 1/3$).

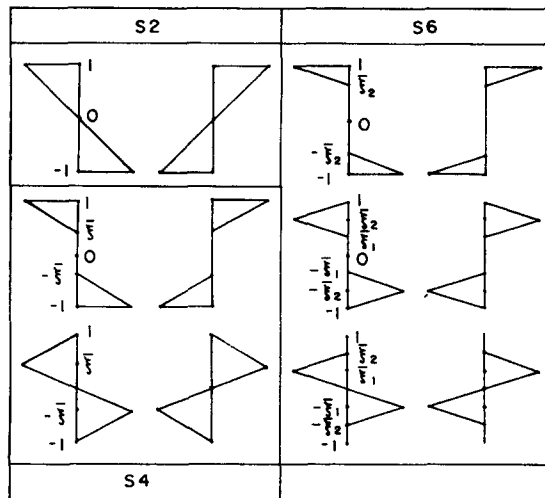

Fig. 5. Interpolations of plastic factors in a cross-section.

$$u(L) = \frac{L^2 M_Y}{EI} \frac{4[10 - 3\sqrt{(3(1-p)) \cdot (p+2)}]}{81p^2} \quad \text{for } \frac{2}{3} \leq p \leq 1 \quad (102)$$

where $EI = Ebh^3/12$ is the flexural rigidity, $M_Y = bh^2\sigma_Y/4$ is the limit bending moment and $p = LP/M_Y$ is the dimensionless load parameter. This curve is shown in Fig. 6 together with some approximations obtained by combining longitudinal and transversal interpolations of plastic multipliers in the proposed statical method.

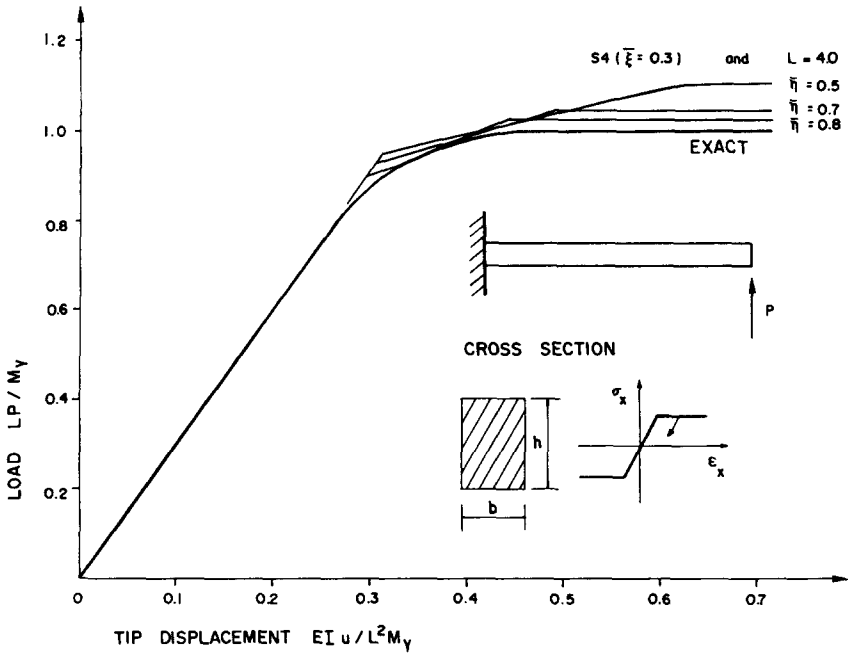

Fig. 6. Load-displacement curves for the cantilever beam with rectangular section of elastic-perfectly plastic material.

The last example is the hyperstatic beam in Fig. 7 with rectangular cross-section of elastic-perfectly plastic material. The exact elastic limit is

$$P = \frac{8}{3} \frac{M_Y}{L} \quad u(L) = \frac{1}{9} \frac{L^2 M_Y}{EI} \tag{103}$$

and the limit load is

$$P = 4 \frac{M_Y}{L} \tag{104}$$

Results obtained with the statical method are shown in Fig. 7.

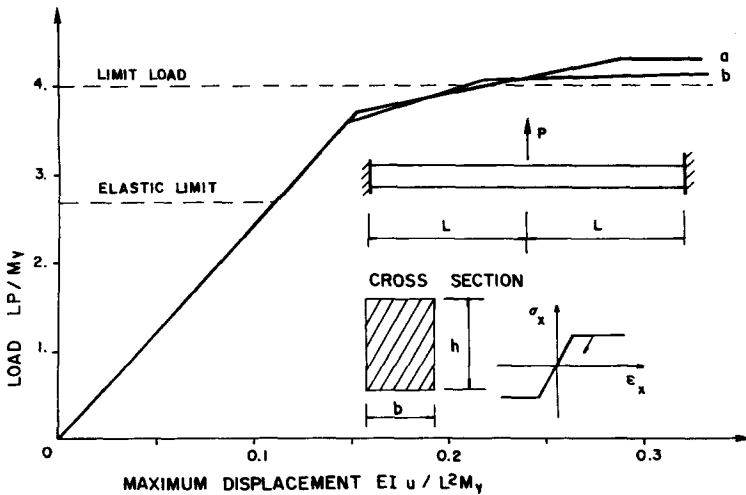

Fig. 7. Load-displacement curves for a beam with both ends fixed and having rectangular section of elastic-perfectly plastic material: a, S4 ($\xi_1 = 0.1$; $\xi_2 = 0.3$) and L4 ($\eta = 0.8$); b, S6 ($\xi_1 = 0.1$; $\xi_2 = 0.3$) and L5 ($\eta = 0.9$).

8. CONCLUDING REMARKS

A statical method for the analysis of elastic-plastic planar frames is developed and compared with kinematical approaches. For the case of plane frames there is a primary argument to prefer the force formulation, namely the possibility of representing all possible stress fields using a finite number of parameters. This is due to the fact that beams are statically determinate in terms of stress resultants. Consequently, there is only one field to be approximated, i.e. the plastic multiplier distribution.

The interpolation of plastic factors has been discussed with reference to the induced discretization of the plastic admissibility constraint. It has been shown that the simplest discretization is derived from the augmented functional containing this constraint as a penalty term. We have also interpreted this discretization and used this to choose proper interpolation bases.

The numerical applications shown are intended to be test examples of the proposed finite elements for frames.

In the application of the force method to other types of structures, the main question is how to represent all possible exact stress distributions preserving the degree of statical redundancy in the element of the continuum discretization. If this condition is reached, all the advantages of the statical formulation, explored here for the case of frames, will be apparent.

Acknowledgements—The authors are grateful to Prof. Raúl A. Feijóo of Laboratorio Nacional de Computação Científica-CNPq (Brasil), for his contribution to the discussions on this work.

REFERENCES

1. G. Maier, Quadratic programming and theory of elastic perfectly plastic structures. *Meccanica* **4**, 1–9 (1968).
2. G. Maier and A. Nappi, On the unified framework provided by mathematical programming to plasticity. In *Mechanics of Material Behaviour* (Edited by G. J. Dvorak and R. T. Shield). Elsevier, Amsterdam (1984).
3. N. Zouain Pereira and R. Feijóo, On kinematical minimum principles for rates and increments in plasticity. *Meccanica* **21**, 23–29 (1986).
4. L. Corradi, On compatible finite element models for elastic plastic analysis. *Meccanica* **13**, 133–150 (1978).
5. L. Corradi and G. Maier, Finite element elastoplastic and limit analysis, some consistency criteria and their implications. In *Nonlinear FE Analysis in Structural Mechanics* (Edited by W. Wunderlich, E. Stein and K. J. Bathe), pp. 290–306. Springer, Berlin (1981).
6. L. Corradi, A displacement formulation for the finite element elastic plastic problem. *Meccanica* **18**, 77–91 (1983).
7. L. Corradi, A refined finite element model for the analysis of elastic plastic frames. *Int. J. Numer. Meth. Engng* **20**, 2155–2174 (1984).
8. M. Bazaraa and C. Shetty, *Nonlinear Programming, Theory and Applications*. Wiley, New York (1979).

APPENDIX

A procedure to generate approximate models for the plastic behaviour of a beam cross-section in terms of piecewise linear yielding functions of a finite number of variables is given. The approximate model is based on: (i) the Euler-Bernoulli assumption; (ii) a plastic factor interpolation in the section; and (iii) substitution of local equations by similar conditions on weighted average values. The static variables adopted are the axial force and the bending moment, and the corresponding kinematical variables are the longitudinal mean deformation and the curvature deformation. The number and interpretation of discrete variables for plastic factor and yielding function depends on the interpolation adopted.

The cross-section is assumed homogeneous and elastic-perfectly plastic with elastic modulus E and (tension-compression) plastic limit σ_Y . At any point of the section, axial strain ε_x , stress σ_x , plastic factor λ_x and yielding function ϕ_x are related by

$$\sigma_x = E(\varepsilon_x - n\lambda_x) \quad (\text{A1})$$

$$\phi_x = n^T \sigma_x - r \quad (\text{A2})$$

where

$$n = [1 \quad -1] \quad r = [\sigma_Y \quad \sigma_Y]^T \quad (\text{A3})$$

$$\lambda_x = [\lambda_+ \quad \lambda_-]^T \quad \phi_x = [\phi_+ \quad \phi_-]^T. \quad (\text{A4})$$

Equilibrium requires that

$$\hat{Q} = \int_A b^T \sigma_x dA \quad (\text{A5})$$

where

$$\hat{Q} = [F \ M]^T \quad b = [1 \ -y]. \quad (\text{A6})$$

The Euler-Bernoulli assumption is now written as

$$\varepsilon_x = b\hat{q} \quad \hat{q} = [\varepsilon \ \kappa]^T. \quad (\text{A7})$$

An interpolation operator ψ_x is defined so that

$$\lambda_x = \psi_x \hat{\lambda} \quad \hat{\lambda} = [\lambda_1 \dots \lambda_m]^T.$$

Consequently, stresses and plastic functions vary in the section according to

$$\sigma_x = Eb\hat{q} - En\psi_x \hat{\lambda} \quad (\text{A8})$$

$$\phi_x = En^T b\hat{q} - En^T n\psi_x \hat{\lambda} - r. \quad (\text{A9})$$

Replacing eqn (A8) in the equilibrium condition we get

$$\hat{Q} = E\Gamma_{qq}\hat{q} - E\Gamma_{q\lambda}\hat{\lambda} \quad (\text{A10})$$

where

$$\Gamma_{qq} = \int_A b^T b dA = \text{diag} [A; \ I] \quad (\text{A11})$$

$$\Gamma_{q\lambda} = \int_A b^T n\psi_x dA. \quad (\text{A12})$$

Equation (A10) can be cast in the form

$$\hat{Q} = D(\hat{q} - N\hat{\lambda}) \quad (\text{A13})$$

for

$$D = E\Gamma_{qq} = \text{diag} [EA; \ EI] \quad (\text{A14})$$

$$N = \Gamma_{qq}^{-1}\Gamma_{q\lambda}. \quad (\text{A15})$$

Let us substitute the local plastic conditions

$$\phi_x \leq 0 \quad \forall y \quad (\text{A16})$$

$$\phi_x \cdot \dot{\lambda}_x = 0 \quad \forall y \quad (\text{A17})$$

by similar equations for weighted average values. If eqn (A17) is replaced by

$$\int_A \phi_x \cdot \dot{\lambda}_x dA = 0 \quad (\text{A18})$$

then the corresponding discrete equation is

$$\phi \cdot \hat{\lambda} = 0 \quad (\text{A19})$$

where

$$\phi = \int_A \psi_x^T \phi_x dA \quad (\text{A20})$$

and we conclude that the local condition, eqn (A16), should be weighted by the transpose interpolation operator to maintain the same structure of equations that describes the plastic behaviour of a work hardening material (see eqns (5)–(9)). Hence the admissibility condition, eqn (A16), is replaced by the following vectorial inequality:

$$\int_A \psi_x^T \phi_x dA \leq 0. \quad (\text{A21})$$

If each interpolation function for plastic factors has a single peak value and decays away from this point,

then the components of the plastic vector ϕ are related with the yielding of layers of the beam around the peak coordinates.

We can find the remaining plastic relations by replacing eqn (A9) in eqn (A20). In this way we get

$$\phi = E\Gamma_{\hat{q}\lambda}^T \hat{q} - E\Gamma_{\lambda\lambda} \hat{\lambda} - R \quad (\text{A22})$$

with

$$\Gamma_{\lambda\lambda} = \int_A \psi_x^T n^T n \psi_x \, dA \quad (\text{A23})$$

$$R = \int_A \psi_x^T r \, dA. \quad (\text{A24})$$

Using eqn (A10) in eqn (A22) gives

$$\phi = N^T \hat{Q} - H\hat{\lambda} - R \quad (\text{A25})$$

where

$$H = E(\Gamma_{\lambda\lambda} - \Gamma_{q\lambda} \Gamma_{qq}^{-1} \Gamma_{q\lambda}). \quad (\text{A26})$$

The expressions obtained for N , and R coincides with those given by Corradi[7] although they were developed here from different considerations. It is also possible to use transversal interpolation together with the longitudinal approximation in the primary continuum formulation, but this has not been done in this paper to avoid complicated notation.